

THE FACTORY AUTOMATION COMPANY

CNC Controls

Product overview

FANUC

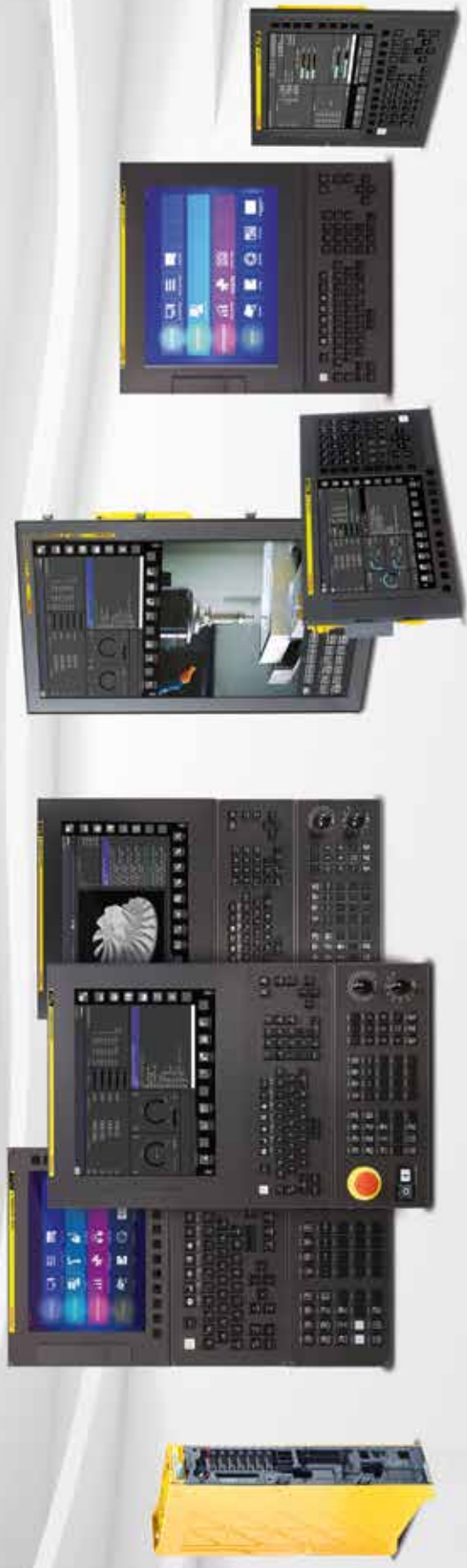

100% FANUC

No. 1 in the world

FANUC is the leading global manufacturer of factory automation, with more than 60 years experience in the development of computer numerical control equipment.

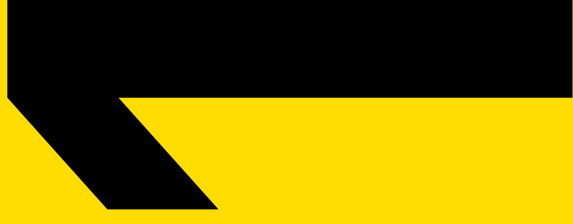

FANUC Laser Systems



FANUC CNC Controls



FANUC Motors



FANUC Amplifiers



Highest quality – shortest processing time

With more than 60 years' experience FANUC offers the widest range of CNC systems in the industry from best value controls with powerful functionality, to high-performance control systems for complex machines – all with fast programming and ease of use, guaranteeing the highest quality and short processing times.

That's how we increase your productivity.

Your advantages:

- 100% FANUC quality
- more than 60 years of experience
- wide range of displays and panels
- stand-alone CNCs
- LCD mounted CNCs
- highest flexibility for your solutions

More than
47
years MTBF
*for 0i-D/F series

60
years
of experience



Flexible package solutions

FANUC offers all major components for your CNC controlled machine: CNC controls, motors and amplifiers in a tailor made and easy to install package for your specific needs. All components are developed and manufactured in-house. The results are superior functional reliability and the highest levels of machine availability – with a mean time between failure of well over forty seven years*, contributing to extremely low cost of ownership.

*for 0i-D/F series

All components
100% FANUC quality

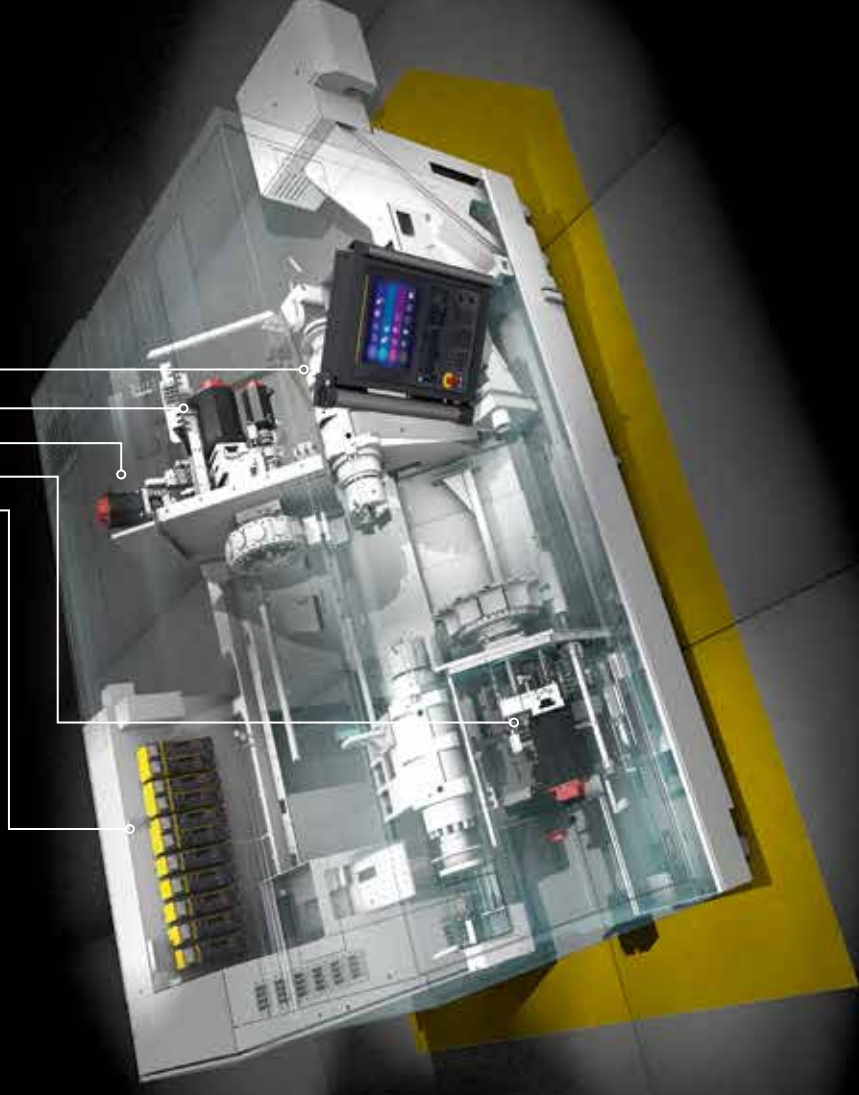

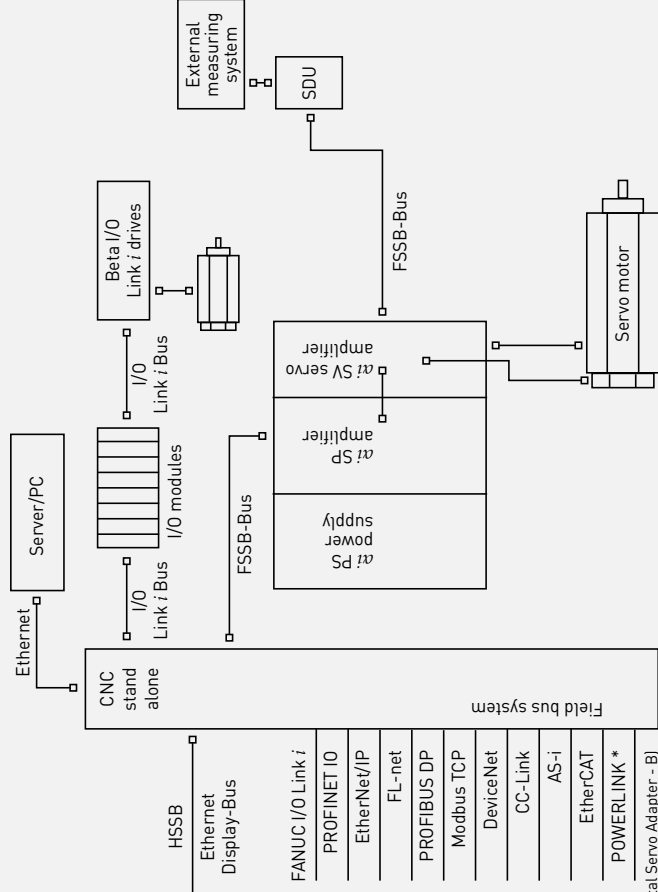
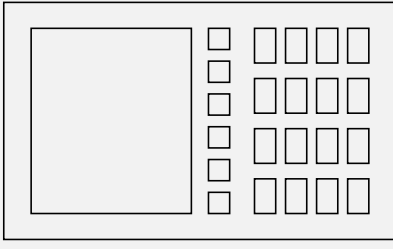

*only Digital Servo Adapter - B)

Your advantages:

- perfect matching components
- all with 100% FANUC quality
- highest reliability for all parts
- high compatibility up and downwards for long time planning reliability
- one strong partner for all components

Unique flexibility

Only FANUC offers you CNC controls in two general versions: LCD mounted as compact solution with less space consumption and less hardware or as highly flexible stand-alone solution. Your benefit: full flexibility for your machine design.

Versatile field bus systems

- FANUC I/O Link *i*
- PROFINET IO
- EtherNet/IP
- FL-net
- PROFIBUS DP
- Modbus TCP
- DeviceNet
- CC-Link

- AS-i
- EtherCAT
- POWERLINK (only Digital Servo Adapter - B)



High-performance CNC for complex machine tools



Key features:

- up to 96 axes, 24 spindle axes and 15 paths
- 5-axis machining
- compound mill/turn or turn/mill machining
- extended integrated preventive maintenance functions
- integrated FANUC Dual Check Safety function
- shop-floor programming via *iHMI* or *MANUAL GUIDE i*
- collision control via 3D Interference Check
- dynamic compensation functions for highest accuracy
- High-Speed Smooth Tool Center Point 5-Axis Compensation
- Learning Control/High-Speed-Cycle-Machining
- integrated high-speed PMC
- high speed cutting
- *iHMI* offering intuitive and extremely user friendly operation
- customisation functions included
- packages and kits combine optional functions for specific purposes

Applications:

- milling
- turning
- grinding
- punching
- laser
- gear cutting

Basic model for multiple control applications



Key features:

- up to 12 axes, 6 spindle axes and 2 paths
- up to 2 additional loader paths
- 4-axis simultaneous and 3+2 axis machining
- ready to use with integrated software package
- excellent performance-to-cost ratio
- integrated FANUC Dual Check Safety function
- shop-floor programming via *iHMI*, *MANUAL GUIDE i* or *TURN MATE i*
- functions for simple customisation included
- integrated high-speed PMC
- high speed and high quality machining package
- maximum look-ahead blocks 400
- common operability, maintainability, network and PMC function with CNC Series 30*i*-MODEL B
- *iHMI* offering intuitive and extremely user friendly operation

Applications:

- milling
- turning
- grinding
- punching
- gear cutting

CNC Series 30*i* / 31*i* / 32*i*-MODEL B Plus

The FANUC Series 30*i* / 31*i* / 32*i*-MODEL B Plus controls are ideal for highly complex machines with multiple axes, multi-path, and high-speed high-precision machining requirements. The hardware and innovative software provide the highest performance, precision and surface quality.

CNC Series 0*i*-MODEL F Plus

The CNC Series 0*i*-MODEL F Plus provides the ideal basic solution for multiple control applications. Ready to use, it boasts latest generation hardware and a complete package of standard software. To maximise productivity on more specific applications, it can be easily customised using a range of additional functions. Combining unbeatable value for money with unrivalled performance and reliability, it includes features and functions usually associated with high performance systems.

CNC for motion control and various applications



Key features:

- up to 32 axis and 10 paths
- ready to use with integrated software package
- integrated FANUC Dual Check Safety function
- additional functions for simple customisation
- integrated high-speed PMC
- CAM function
- perfect combination of pressure and position control

Applications:

- packing
- handling
- wrapping
- sawing
- pressing
- punching
- bending
- spinning
- friction welding

Servo systems for high-speed and high-accuracy applications



Key features:

- DSA-B - driving FANUC motors with any 3rd party controller (NC, PLC, PC-based)
- easy integration to your existing technology and application (e.g. injection moulding machine, press machine, die cushion, press brake, testing machine, gantry or any milling, turning, grinding machine)
- maximum control axes up to 16 axes per DSA
- supports CiA402 drive profile including SyncManager
- compatible with FANUC's entire motor line-up such as servo, spindle, torque and linear motors
- use any motor of FANUC's large motor range from 0.2Nm to 3000Nm servo motors
- available interfaces: EtherCAT, POWERLINK, Pulse Input, Analog Voltage Input

Power Motion *i*-MODEL A Plus

The FANUC CNC Power Motion *i*-A Plus is ideal for efficient motion control and a wide range of various applications from positioning up to multi-path axis interpolation.

Digital Servo Adapter-MODEL B with EtherCAT

FANUC's Digital Servo Adapter allows for FANUC servo motors to be run from a captive controller. This is ideal for industrial machines such as servo press machines, wire saw machines and electric injection molding machines.

PMC function	40%	40%	40%	40%	40%	40%	40%	2048	2048	2048	2048	40%
Max. number of I/O	40%	40%	40%	40%	40%	40%	40%	2048	2048	2048	2048	40%
Max. number of I/O Link <i>i</i> channels	2	2	2	2	2	2	2	2	2	2	2	2
Max. number of PMC channels	5	5	5	5	5	5	5	3	3	3	3	5
Maximum steps	300 000	300 000	300 000	300 000	300 000	300 000	300 000	100 000	100 000	100 000	100 000	300 000
Function Block function	•	•	•	•	•	•	•	•	•	•	•	•
CNC functions												
3D Interference check	•	•	•	•	•	•	•	-	-	-	-	-
Dual Check Safety	•	•	•	•	•	•	•	•	•	•	•	•
Smart Machine Control	•	•	•	•	•	•	•	•	•	•	•	•
Program Restart / Quick Program Restart	• / •	• / •	• / •	• / •	• / •	• / •	• / •	• / •	• / •	• / •	• / •	-
Nano Interpolation	•	•	•	•	•	•	•	•	•	•	•	•
Smooth Tolerance Control	•	•	•	•	•	•	•	-	-	-	-	-
Fine Surface Technology	•	•	•	•	•	•	•	•	•	•	•	-
AI Contour Control	•	•	•	•	•	•	•	•	•	•	•	•
Macro Executor / C-Executor / FANUC Picture / FOCAS	• / • / • / •	• / • / • / •	• / • / • / •	• / • / • / •	• / • / • / •	• / • / • / •	• / • / • / •	• / • / • / •	• / • / • / •	• / • / • / •	• / • / • / •	• / • / • / •
MANUAL GUIDE <i>i</i> / MANUAL GUIDE 0 <i>i</i>	•	•	•	•	•	•	•	• / •	• / •	• / •	• / •	-
Tool Functions / Tool Management System	• / •	• / •	• / •	• / •	• / •	• / •	• / •	- / •	- / •	- / •	- / •	• / -
Tilted Working Plane / Tool Center Point Control	• / •	• / •	• / •	• / •	• / •	• / •	• / •	• / -	• / -	• / -	• / -	-
Smooth simultaneous 5-axis machining	•	•	•	•	•	•	•	-	-	-	-	-
Error Compensation / Volumetric Error Compensation	• / •	• / •	• / •	• / •	• / •	• / •	• / •	• / -	• / -	• / -	• / -	• / -
Technologies												
Milling	•	•	•	•	•	•	•	•	•	•	•	-
Turning	•	•	•	•	•	•	•	-	-	-	-	-
Grinding	•	•	•	•	•	•	•	•	•	•	•	-
Punching	•	-	-	-	-	-	-	-	-	-	-	-
Laser	•	-	-	-	-	-	-	-	-	-	*	-

All panels and screens shown are examples only.

Configure your CNC

Each FANUC CNC series offers a diverse range of panels and screen solutions. Your benefit: a wide variety of configuration options for every specific machining solution providing full flexibility for your ideas.



The FANUC standard LCD display is available in 2 basic versions:

LCD-mounted type embedded in the CNC, physically mounted directly behind the LCD panel or as a separate stand-alone display unit which is connected to the CNC using a fiber optics cable.

Standard LCD displays are available in sizes from 10.4" in diagonal up to 19", with and without touch panel. LCD displays with touch panel can be used without any additional keyboards and push button panels and can provide small and smart HMI solutions for compact machines.

The standard LCD display generates the content of the screens, including customised HMI applications in the CNC. Or choose an LCD display with PC that provides PC CPU and storage capabilities at the display level.

Choose the Manual Data Input (MDI) device of your CNC control from a selection of a small size MDI, a standard size MDI, a 68-key MDI or a full keyboard with either English or symbolic key sheets for a variety of applications. Depending on the type, the device has alphanumeric keys to input part programs, operation keys like RESET, PAGE UP, PAGE DOWN, HELP and menu keys to switch between several menu screens.

The new Machine Operation Panel (MOP) comes with additional and improved safety options. All the buttons on this control panel are equipped with double wired keys and further safety functions like override switches. An integral ESP button enhances safety in case of emergency. Via the FANUC I/O link *i*, the operator panel communicates with the CNC system and is thus easily integrated into the FANUC Dual Check Safety system. Like its forerunner, the innovative Safety MOP has exchangeable key tops which allow a customised key layout.

FANUC iHMI - Simple. Efficient. Intuitive.

FANUC iHMI has been designed to be extremely easy to use. Intuitive menu icons, high-visibility design and animated features take the head-scratching out of complex machining operations, making accessing even the most sophisticated programs and functionalities straightforward. Despite its more intuitive layout, users will nevertheless find that it provides a familiar FANUC user experience.

Various cycles

- turning
- milling
- measurement

CNC operation screen

Simple

Easy operation along process flow with integration of three screens:



Friendly

Help troubleshooting – one-stop problem-solving

Graphical

Intuitive icons and high-visibility design with animated features

Safety function DCS

The certified FANUC Dual Check Safety (DCS) function provides a high level of safety for the operator during operations with protection activated while power is still applied. In case of an abnormal function FANUC DCS quickly shuts off power to protect the operator allowing a quick restart of the machine tool operation. Special functions are available to simplify the creation of the machine documentation, e.g. Test Mode Function for Dual Check Safety.

Your benefits:

- reliable operator safety
- fewer external safety circuits required
- overall cost reduction of the safety solution
- certified to comply to the actual safety standards



Tool Manager

Uniform tool information management for machine

Machine collision avoidance

Uniform tool information management for machine

Maintenance manager

Observe CNC and machine parts and set alert for exchange time

Servo viewer

Measure and display various kinds of data



Data logger

Investigate cause of problem while machining

Manual viewer

Always refer to the machine's manual

Tool Manager

Uniform tool information management for machine

- up to 1000 tools with tool management option
- up to 1024 sets of tools with tool life management option
- up to 1000 tools when the CNC option is invalid
- tool catalogue data available for about 2000 tools
- VERICUT format (TSL file) CAM/simulation software is compatible with tool data

Data logger

Investigate cause of problem while machining

- amount of data per second under 64 KB

Data types:

- position of axes
- CNC status
- PMC data
- macro variable data
- information of servo/spindle
- operational information
- alarm information etc.

Manual viewer

Always refer to the machine's manual

- add MTB's manuals and classify into an arbitrary group
- use multiform file formats (HTML, TXT, PDF)
- display manuals according to NC language setting
- memory capacity for manuals is limited to 500 MB

Machine collision avoidance

Model, prevent interference and add to CNC before machining

- collision status can be confirmed graphically
- forecast positions for safe, precise collision detection
- based on CGTech Co's CAS (Collision Avoidance Software)
- maximum forecast time up to 600 msec.
- create 3D models of the machine on a PC

Servo viewer

Measure and display various kinds of data

- servo and spindle data, e.g. position, speed and torque
- PMC data
- CNC status information, e.g. program number, M/S/T codes
- analyze the axis movement and CNC operation timing
- optimize the CNC program to reduce cycle times
- monitor the machine's condition by periodical measurements

Maintenance manager

Observe CNC and machine parts and set alert for exchange time

- specified by usage time, amount of movement, PMC counter etc.
- add a max. of 100 items as orig. monitoring item
- min. 1 sec monitoring period
- time savings of an hour or more
- easy to add original monitoring item and notification information

Original FANUC Smart Software Tools

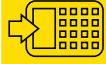

Connectivity and Development Tools

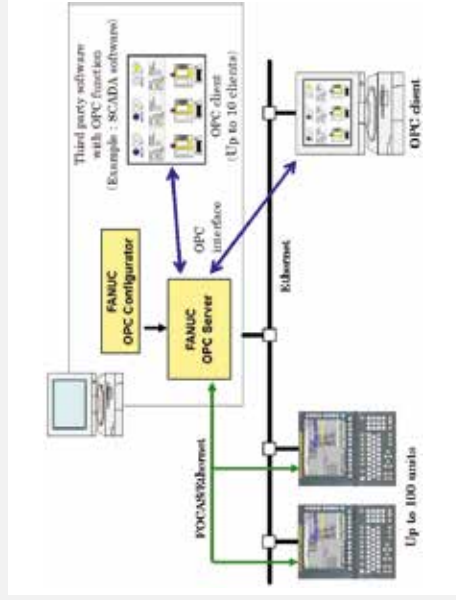

OPC SERVER

OPC is a communication standard for industrial automation. The FANUC OPC Server is a Windows® application software for PCs that converts the communication protocol between OPC and FOCAS. Devices with an OPC client functionality can communicate with FANUC CNCs via this software.

Benefit

- Connect to a third party application software that has OPC client functionality easily

Details

- Supports OPC-UA standard
- Supports OPC-DA standard 3.0, 2.0 and 1.0a
- Read and write PMC data
- One PC can communicate with up to 100 CNCs
- CNC can communicate with a PC via Embedded Ethernet or Fast Ethernet

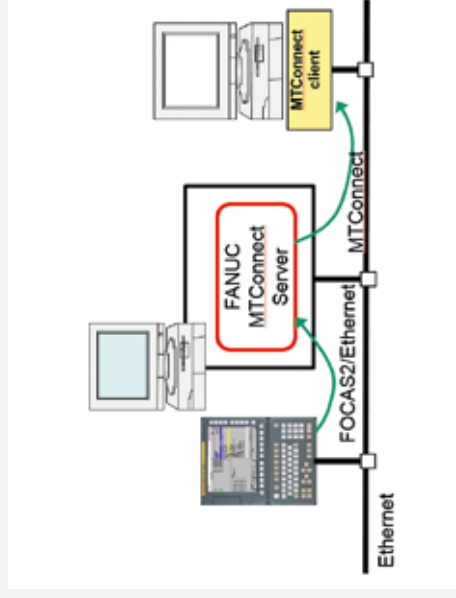

MTCONNECT SERVER

MTConnect is a protocol to retrieve data from factory equipment such as machine tools by client applications used for data analysis and monitoring. With FANUC MTConnect Server, you can read data from machine tools equipped with FANUC CNCs. MTConnect Server collects data from CNCs and PMCs and provides them to client applications via MTConnect protocol. The option "MTConnect Server Function" is required on the CNC in order to use this software.

Benefit

- Read data from FANUC CNCs and PMCs via MTConnect
- Use client applications from the market that require MTConnect

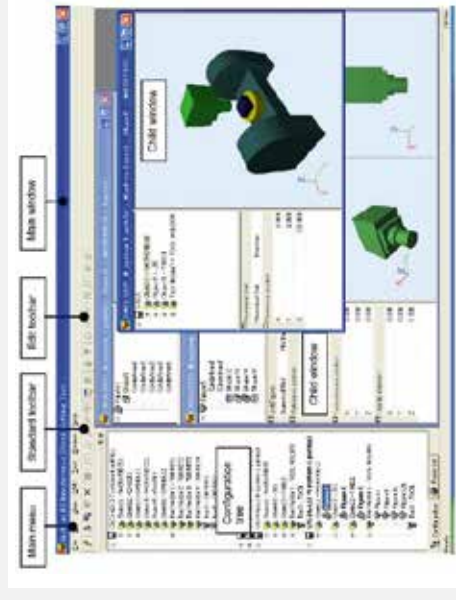

BUILT-IN 3D INTERFERENCE CHECK SETTING TOOL

This Windows® application allows the setting of the Series 30i/31i Built-In 3D Interference Check functions through a PC – including creation, setting and display of the 3D objects and figures representing the work piece, the fixtures and the tools, object moving and axis settings, real-time 3D interference check monitoring related to the Built-In 3D Interference Check Function. Your benefits: A simplified management of the 3D Interference Check Project, easy import of 3D shapes to accelerate the setup, increased efficiency in managing multiple machine settings and large projects – and a simplified start-up through online functions.

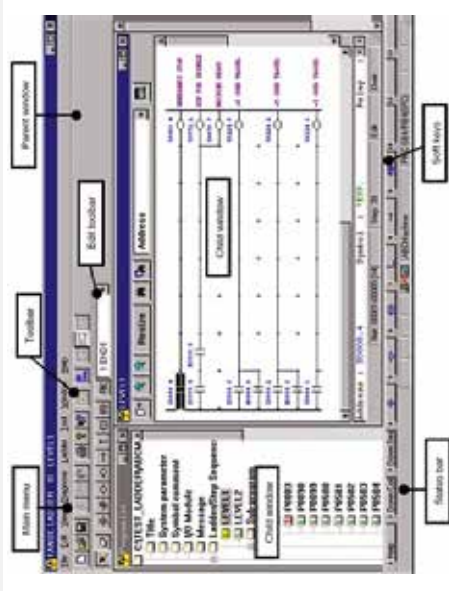

FANUC LADDER-III

FANUC LADDER-III is the standard programming system for creating, displaying, editing, printing, monitoring, and debugging ladder sequence programs for CNC PMC ladder. It works with CNC GUIDE on one or multiple PCs and is easy to connect to the CNC via Ethernet.

MACRO EXECUTOR AND C-LANGUAGE EXECUTOR

Your powerful programming language for machining or machine management purpose: The Macro Executor function converts, loads and executes all Custom Macro programs that you create as executable macro programs that can be called from a standard part program. Using the C-Language Executor functionality as powerful programming language for machining or machine management purpose enables you to develop functions and programs adding new functionality to your CNC, as well as machine control functions written in C, and modify Macro Programs to follow machine and production evolution. Up to two independent real-time tasks are also available to implement time critical functionalities.

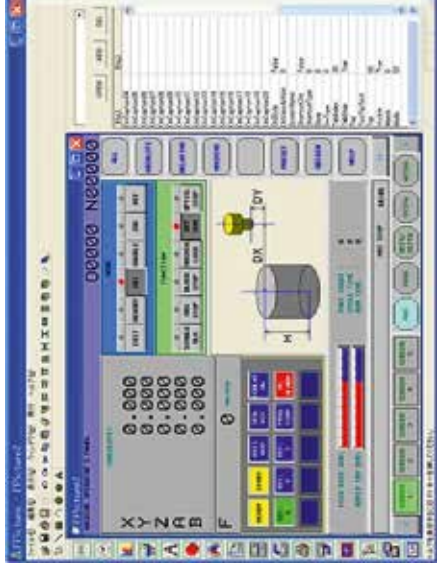

FANUC PICTURE

FANUC Picture offers an easy way to create customised operator and HMI screens for complex processes and all the functions and features of modern HMI software tools. It supports objects, animations, data, and multi-language and features a macro language to run routines to perform tasks. The screens are compiled and stored in the CNC Flash-ROM (FROM) memory or on iHMI. Custom functions written in C/C++ can be called from FANUC Picture. Your benefits: simplification of operator work, less operation error, easier machine and process control and an improved overall productivity.

CNC GUIDE FOR TRAINING AND DEVELOPMENT

Cut your training costs: CNC GUIDE provides a realistic operation, and part programming environment at a fraction of the cost using a production machine tool. Operators perform exercises learning conventional G-code programming, including canned cycles and custom macros and FANUC MANUAL GUIDE i. Create a superior software development environment for your FANUC CNCs! CNC GUIDE adds the PMC ladder, support for the standard FANUC operator panel with customizable key top. CNC GUIDE offers a valuable aid in the development of FANUC LADDER III, FANUC PICTURE, C-Language Executor and MACRO EXECUTOR applications.

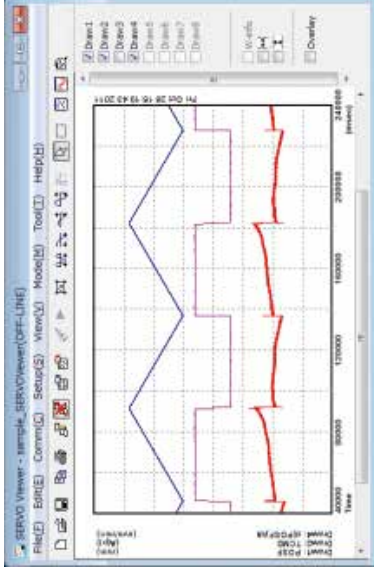

SERVO VIEWER

SERVO Viewer is a Windows® application software that enables to measure and display various kinds of data from a machine tool with a FANUC CNC. It is possible to acquire and view servo/spindle data such as position, speed and torque, PMC signals, or CNC status information such as program number, sequence number or M/S/T codes.

Benefit

- Analyze the axis movement and CNC operation timing
- Optimize the CNC program to reduce cycle times
- Monitor the machine's condition by periodical measurements

FOCAS LIBRARY

FOCAS (FANUC Open CNC API Specification) is the protocol used to interact with your FANUC CNC from an external PC. The FOCAS library provides all required functions to develop Windows® applications which can communicate with a FANUC CNC via Ethernet or HSSB (fiber optics). Your benefits: Creation of customised functions and applications under Windows®, modification of Macro Programs to follow machine and production evolution, and easy access to many resources of the FANUC CNC to create advanced applications.

Original FANUC Smart Software Tools



Optimisation Tool

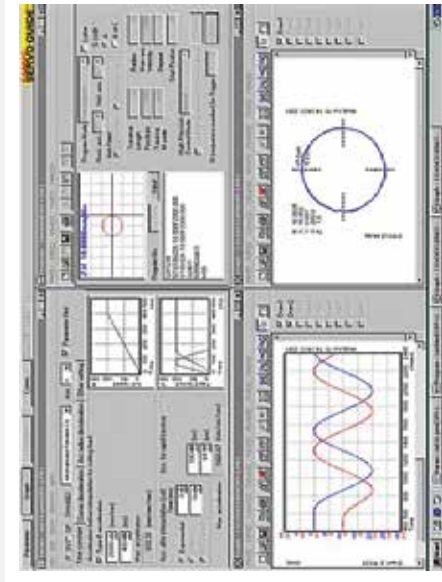

FANUC SERVO GUIDE

FANUC SERVO GUIDE is a Windows® application for quick and easy optimisation of servo and spindle axes. This software provides the integrated environment to test programs, set parameters and data measurement, needed for servo and spindle tuning. Direct connection between PC and CNC is possible through Ethernet.



CNC User Interface for PC

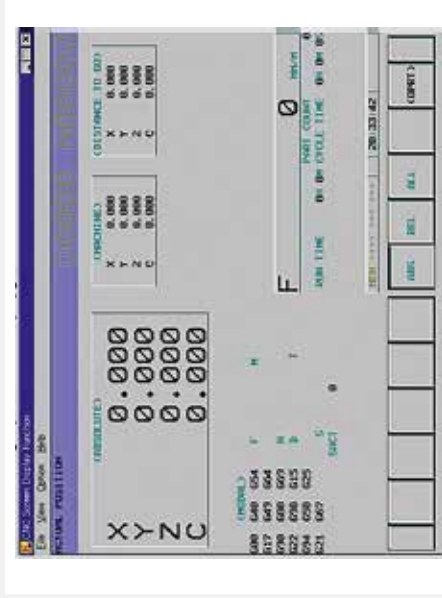

SCREEN DISPLAY FUNCTION

Our best tool for CNC maintenance and setup on Open CNC systems: Simplify the access to the CNC screen from a PC and create an efficient remote maintenance tool. The Windows® application provides a straightforward solution to display CNC original and custom screens on PC, which is connected by HSSB or Ethernet. SDF does not need to be updated at CNC function or customisation change.



User Tool

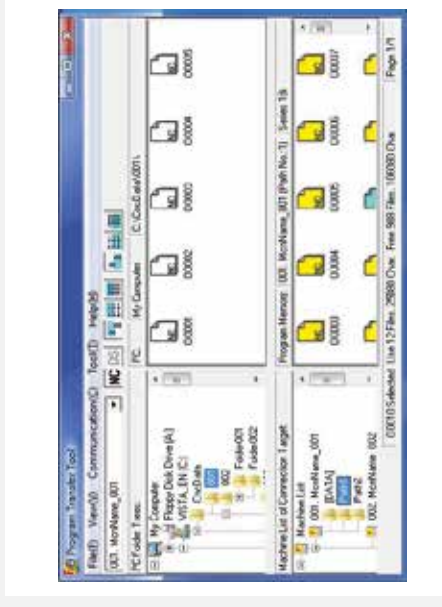

PROGRAM TRANSFER TOOL

Using this Windows® application enables you to manage part programs, tool offsets, custom Macro value, work piece origin offset, and tool management with easy connection between the CNC memory or data server and a PC by Ethernet.



Shop Floor Programming Tools

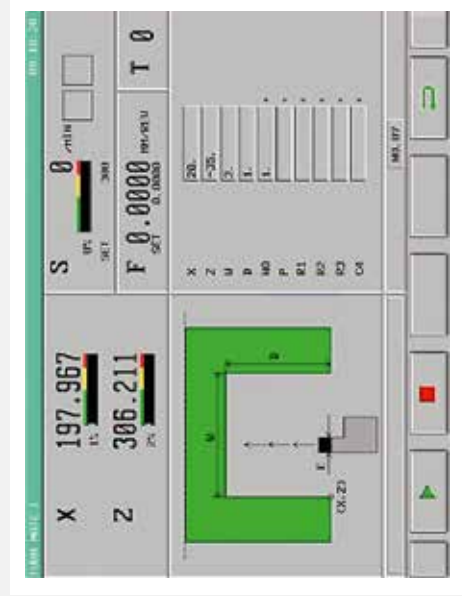

TURN MATE *i*

Increase the productivity and flexibility of your turning machines using FANUC TURN MATE *i* by simplified parts programming! The conversational software function assists the operation of entry-level turning machines – no knowledge of G code ISO language is required to program work pieces, and operation is easy with clearly laid out screens.

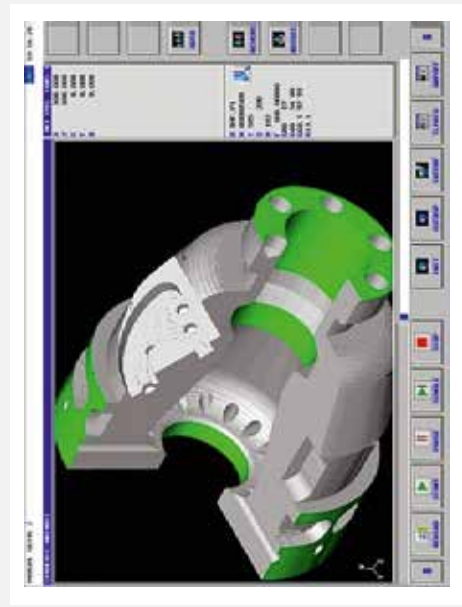

MANUAL GUIDE *i*

Create your part programs from a drawing to a production part in just a few steps! MANUAL GUIDE *i* supports turning, milling and compound machining applications and can be used on simple machines as well as on very advanced machining processes. The software is built around the standard CNC ISO code format and provides an ergonomic Graphical User Interface (GUI) with user-friendly icons. All of the relevant information is displayed on a single CNC screen. Your benefits: assisted and conversational programming of machining cycles, easy programming of parts, easy simulation – and an overall higher productivity by reduction of the total time from drawing to cutting.



Our strength: Service and Support

Intensive application support and personal customer service are major aspects of the FANUC world – from the first step to the last. A very skilled and dedicated service team will help you to build and operate the most efficient machines. Always flexible, always fast, always near. The special FANUC Service packages improves the performance of your machines even further.

More than
2300
service
engineers

More than
260
subsidiaries
worldwide



Wherever you need us: we are there

With the largest global network of local subsidiaries in all continents, we are always there to meet your needs. Fast and efficient – 24/7. So you always have a local contact that speaks your language.



FANUC Academy

We help you get the most potential out of your automation through optimising the skills of your employees. Certified FANUC instructors train them in our fully equipped professional training centres, or at your own premises, using standard training modules as well as customised training packages to meet your specific needs.

Let's optimise your productivity.



Service First

One common servo and control platform – Infinite opportunities THAT'S FANUC!

FA CNCs, Servo Motors and Lasers	ROBOTS Industrial Robots, Accessories and Software	ROBOCUT CNC Wire-Cut Electric Discharge Machines
ROBODRILL Compact CNC Machining Centres	ROBOSHOT Electric CNC Injection Moulding Machines	IoT Industry 4.0 solutions

